

KTZ45.5-53

Kontroll-Nr. --

2016-01-31 V.18 / 1.10.2015

KTZ45.5-53			
Item	Item no.	Description	Quant.
1	140-074-15	Hex.Bolt M10x20 SUS304 (EN X5CrNi18-10) Stainless Steel	3
2	068-000-36	Handle KTZ23.7/45.5 SGP+SS	1
3	010-121-19	Cable Clip Rubber No.1 NBR	1
4	010-120-18	Cable Clip No.2-1 SPC	1
5	140-032-37	Hex.Bolt M6x15 SWRM	1
6	141-004-59	Hex.Nut M6 SWRM	1
7	095-131-18	Chain d4(3-Link) SS	1
8	011-110-11	Shackle 6mm SS	1
9	001-TEG-02	Cabtyre Cable Set (20m) H07RN-F4Cx2,5mm ² without stuffing box	1
9	M01-TEG-02	Cabtyre Cable Set (20m) NSSHÖU 4Cx2,5mm ²	1
10	140-060-18	Hex.Bolt M8x50 SUS304	4
11	006-167-17	Stuffing Box No.1-3 FC	1
12	122-121-12	O-Ring G-50 NBR	1
13	004-167-11	Cable Bush No.1 CR	1
14	008-156-19	Mould Cover No.1-3 ADC	1
15	009-123-10	Terminal P-5.5 CU	4
16	009-101-12	Terminal(C/W Screw) d12x(d6.6xd6.6)x25l BSBM	4
17	009-123-10	Terminal P-5.5 CU	4
18	002-135-14	Heat Shrink Tube (Sold per meter) A(d15x0.3t) (Vm)	1
19	002-132-11	Heat Shrink Tube (Sold per meter) A4(d17x0.3t) (Vm)	1
20	140-000-87	Hex.Bolt M10x35(B=14) SUS304 (EN-X5CrNi18-10)	4
21	142-128-24	Plain Washer M10 Kaltgewalztes Blech	4
22	032-000-93	Hose Coupling (for EUR) KTZ43.7-53/63(Angle,BSPT-4) FC	1
22	032-000-80	Hose Coupling KTZ43.7-53/63(Angle) ADC	1
23	121-001-48	Packing (Hose Coupling) KTZ-3.7/7.5(Angle) NBR	1
24	140-079-10	Hex.Bolt M10x40 SUS304 (EN X5Cr18-10)	4
25	142-164-19	Spring Washer M10 SUS304 (EN X5CrNi18-10)	4
26	070-117-11	L-Shape Fitting 40x25x4.5t d13Hole SPC	1
27	050-001-10	Motor Bracket FC	1
28	140-288-14	Hex. Socket Cap Bolt M10x35 SUS304 (EN X5CrNi18-10) Stainless Steel	1
29	142-164-19	Spring Washer M10 SUS304 (EN X5CrNi18-10)	1
30	122-000-09	O-Ring 195xd3.8 NBR	1
31	053-506-18	Motor Protector 380-420V-50HZ 380-460V-60HZ KA314-HIMXL00 (B.C)	1
32	143-126-12	Pan Screw (w/Spring Washer/Plain Washer) M4x12 SWRM	2
33	009-294-13	Earth Terminal 3.5mmx170L	1
34	143-085-34	Pan Screw (w/Spring Washer) M4x6 C3604 (EN CuZn39Pb3)	1
35	142-197-11	Wave Washer #6305 SK-5	1
36	052-108-13	Bearing 6305ZZC3	1
37	122-244-12	O-Ring 61.4xd3.1 NBR	1
38	058-000-35	Lead Wire Protection Plate d84xd199.5x1.6t PE	1
39	055-002-59	Rotor	1
40	147-026-13	Impeller Key 5x5x25l Stainless Steel	1
41	056-007-29	Stator 380/400/415V-50Hz(EUR)	1
42	121-000-14	Packing (Water Way, Upp.) KTZ35.5/67.5-51/61 NBR	1
43	064-000-02	Motor Frame FC	1
44	140-078-19	Hex.Bolt M10x35 SUS304 (EN X5CrNi18-10)	4
45	142-164-19	Spring Washer M10 SUS304 (EN X5CrNi18-10)	4
46	121-247-12	Packing (Oil Plug) d12.3xd18x2t PE	1
47	140-000-17	Hex.Bolt (w/Flange) M12x15(Oil Plug) SUS304 (EN X5CrNi18-10) Stainless Steel	1
48	140-000-23	Hex.Bolt (w/Spring Washer) M5x10 SWRM	4
49	062-000-02	Bearing Cover d5.5xd18x2t SPC	4
50	052-111-19	Bearing 6308ZZC3	1
51	122-135-19	O-Ring G-120 NBR	1
52	060-001-38	Bearing Housing FC	1
53	142-163-34	Spring Washer M8 SWRH	4
54	140-054-48	Hex.Bolt M8x20 SWRM	4
55	025-000-07	Mechanical Seal H-25T SiC	1
56	143-070-23	Pan Screw M5x6 SWRM	2
57	030-143-12	Oil Lifter H-25(A)(T) Resin	1
58	143-070-10	Pan Screw M5x6 SWRM	4
59	030-148-17	Seal Stopper For HT-2530 SPCC	1
60	122-283-13	O-Ring 165xd3.1 NBR	1
61	121-124-12	Packing (Water Way, Low.) KTV-37/55 NBR	1
62	020-001-04	Pump Casing KTZ35.5/45.5 FC	1
63	026-144-49	Oil Seal TC-40588 NBR	1
64	040-106-27	Impeller Shim d20.2xd30x0.3t SUS304 (EN X5CrNi18-10) Stainless Steel	1
65	021-565-29	Impeller (50HZ) 50Hz HiCrFC	1
66	047-104-26	Impeller Thread Protect.Cover No.3B(18) SUS304 (EN X5CrNi18-10) Stainless Steel	1
67	142-166-11	Spring Washer M16 SUS304 (EN X5Cr18-10)	1
68	141-033-15	Hex.Cap Nut M16 SUS304 (EN X5Cr18-10)	1
69	120-109-21	Packing (S.Cover) d180xd220x0.3t PE	1
70	022-000-56	Suction Cover KTZ43.7 (FCD)	1
71	142-128-24	Plain Washer M10 Kaltgewalztes Blech	3
72	140-074-15	Hex.Bolt M10x20 SUS304 (EN X5CrNi18-10) Stainless Steel	3
73	142-128-24	Plain Washer M10 Kaltgewalztes Blech	3
74	144-000-31	Stud Bolt M10x94(20/14) DIN 1.4006 (EN X12Cr13)Edelstahl	3
75	023-471-10	Strainer Stand KTZ23.7/45.5 SPCC	1
76	142-128-24	Plain Washer M10 Kaltgewalztes Blech	3
77	141-006-77	Hex.Nut M10 S45C	3
	173-003-41	Packing & O-Ring Set	1
	183-008-11	"Impeller Puller "A Type No.3 1""	1
	##oilVG32	oil Turbine Oil ISO VG32	1100

Exploded View KTZ45.5-53

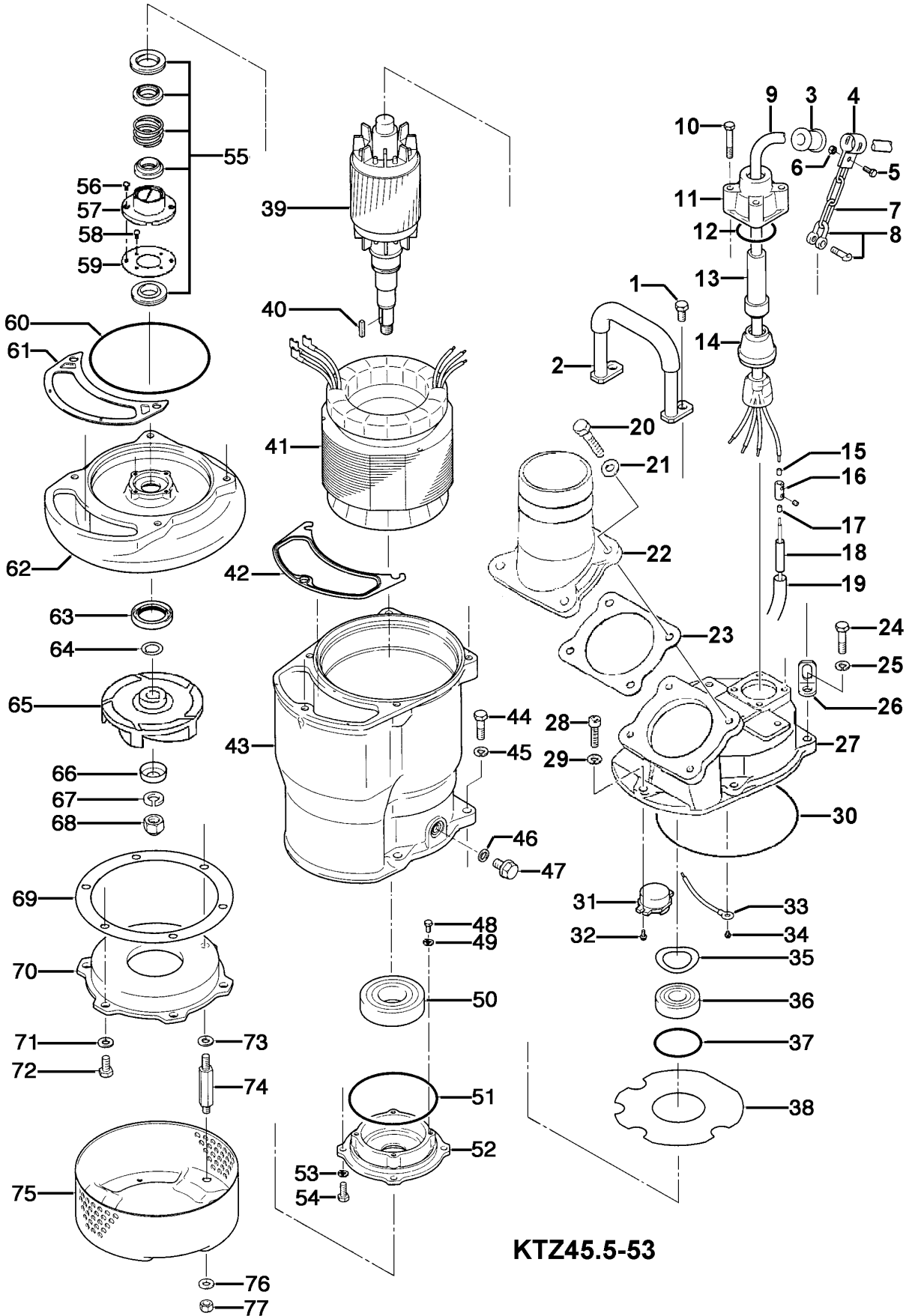

KTZ45.5-53